

32-1047 REV 1

These compact and economical test stands are ideal for low force applications with relatively small sample sizes. The ES10 and ES20 produce both tensile and compressive force up to 100 lbf. Choose between lever operation for quick tests or hand wheel operation for better control of motion. Combine these test stands with Mark-10 digital force gauges and gripping fixtures to create complete testing solutions.

Specifications

Load capacity:	100 lbf [500 N]
Maximum travel:	≈9 in [228.6 mm], depending on gauge, gripping fixtures, and sample size
Loading method:	
ES10:	Lever
ES20:	Hand wheel
Travel rate:	
ES10:	1.05 in [26.7 mm] per lever rev.
ES20:	0.083 in [2.1 mm] per hand wheel rev.
Weight:	10 lb [4.5 kg]
Included accessories:	Force gauge mounting hardware
Warranty:	3 years (see individual statement for details)

Optional Equipment

Dial travel indicator ES001	1" displacement, 0.001" resolution. Mounts onto the test stand and can be repositioned.
Digital travel indicator ES002	1" displacement, 0.0005" / 0.01 mm resolution. Includes zero and in/mm selector buttons. Mounts onto the test stand and can be repositioned.
Base plate 14-1068	Steel base plate has 25 #10-32 threaded holes for fixture mounting

>> Dial travel indicator



>> Digital travel indicator



>> Base plate



Dimensions

in [mm]

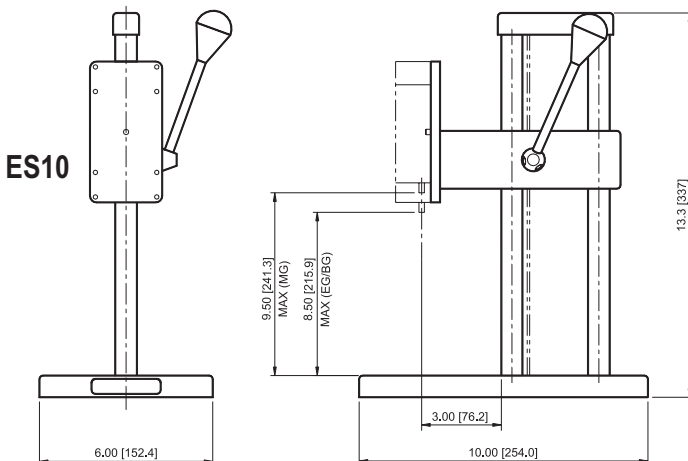

The ES20 is shown in a peel testing application with Series MG digital force gauge, and film & paper grips.

The ES10 is shown in a wire terminal pull-off test, with Series MG digital force gauge, wire terminal grip, and dual roller grip.

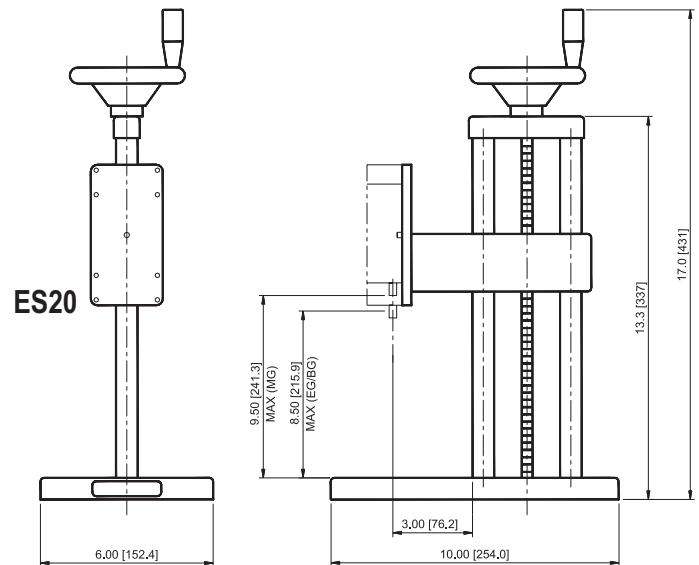

Ordering Information

Model No.	Description
ES10	Test stand, lever-operated, 100 lbf
ES20	Test stand, hand wheel-operated, 100 lbf
ES001	Dial Indicator Kit for ES10 / ES20, 1" travel
ES002	Digital Indicator Kit for ES10 / ES20, 1" travel
14-1068	Base plate, tapped holes