

# MSI3360

CHALLENGER 2  
CRANE SCALES

**ONLINE PRODUCT  
WARRANTY REGISTRATION**

Click here to activate your  
MSI Product Warranty today.

[www.msiscales.com](http://www.msiscales.com)

## User Guide

*Quality  
Industrial  
Weighing  
and Force  
Measurement  
Equipment*

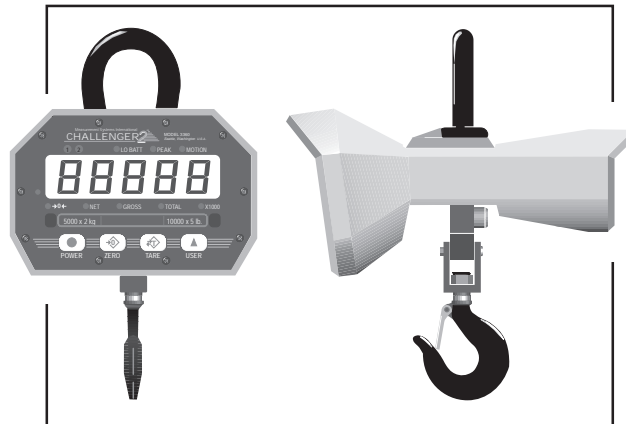

*Measurement  
Systems  
International*

**IMPORTANT**

Please read this manual carefully before using the MSI-3360 Challenger 2

Program Number \_\_\_\_\_ Capacity and Resolution \_\_\_\_\_

Serial Number \_\_\_\_\_ Cal Number \_\_\_\_\_

TABLE OF CONTENTS

Introduction .....	4	Subsequent Calibration .....	29
Specifications .....	4	Fine Calibration (F-CAL) .....	29
Features .....	6	Calibration with Calibration Offset Resistor (CAL-r) .....	30
Options .....	7	Standards (StAnd) .....	31
Unpacking .....	7	Remote Control (r-Ctl) .....	31
Assembly .....	7	Auto ZERO Tracking (AZt) .....	32
Battery Pack .....	8	INFRARED REMOTE OPTION .....	33
Battery Charger .....	9	Introduction .....	33
Operation Guide .....	10	Remote Controller Operation .....	34
POWER .....	11	To Enable Remote Controller .....	34
ZERO .....	11	Batteries .....	34
TARE .....	12	To Set Remote Controller Access Codes .....	35
USER .....	13	The Scale and 2nd Keys .....	35
TEST (tESt) .....	13	POWER .....	36
Accessing the Service Counters .....	14	ZERO .....	36
To Reset the Service Counter .....	15	TARE .....	36
TOTAL (totAL) .....	15	RECALL TARE .....	36
Manual TOTAL .....	15	NET/GROSS .....	36
Auto TOTAL .....	16	USER .....	36
To Clear the Last Totaled Weight .....	17	UNITS .....	37
To Clear the TOTAL Value .....	17	TOTAL .....	37
Viewing TOTAL .....	17	VIEW TOTAL (VIEW $\Sigma$ ) .....	37
UNIT (kg/lb) .....	18	Clear Last Total .....	37
PEAK (Phold) .....	18	Clear All Totals .....	38
NET/GROSS (nEtGr) .....	19	Keyboard Tare .....	38
Scale Setup .....	19	Display Key .....	39
Quick USER Setup Guide .....	20	SETPOINTS .....	39
Function (Func) .....	21	ID # .....	40
Automatic Power Off (A-OFF) .....	21	PRINT .....	40
Filter (Filtr) .....	22	SETUP .....	40
LED Brightness (LEdS) .....	22	Troubleshooting Guide .....	42
Unit (kg/lb) .....	23	Service Counter Warning .....	44
Setpoints (StPt1, StPt2) .....	23	The MSI Limited Warranty .....	45
Set Point Entry .....	23	Proper Loading Procedures .....	46
To Disable a Set Point .....	24		
TOTAL (totAL) .....	25		
System Initialize .....	25		
Calibration Setup .....	26		
Quick Calibration Setup Guide .....	27		
Calibration (CAL) .....	27		
Initial Calibration .....	27		

## INTRODUCTION

The MSI-3360 Challenger 2 is a combination of the sound and proven mechanical design of the original Challenger with today's most advanced electronics to provide a superb feature set unmatched by any scale in its class or price range. The multi-purpose hanging scale is ideal for situations in which head-room is at a minimum. The Challenger 2 is versatile, reliable, accurate and easy to operate.

## SPECIFICATIONS

Accuracy: 0.1% of applied load  $\pm$  one displayable increment  
 Resolution: Standard displayed resolution: 2500 counts Internal A/D resolution: 1,048,576 counts (20 bits)

Capacities:

lb	250	500	1000	2000	5000	10,000	15,000
kg	125	250	500	1000	2500	5000	7500

Power: Battery operated, rechargeable sealed lead acid battery pack (standard Challenger Charger); up to 100 hours of battery life with Automatic Sleep Mode and Automatic Power Off

Display: 5 digit, large 1.2 in (30 mm) high numeric red GaAIAs Light Emitting Diode (LED)

Operating Temperature:  
 - 4°F to +122°F (-20°C to +50°C) NTEP range -10°C to +40°C

Operating Time: 50 hours min./100 hours max. (depends on operating mode)

Enclosure: NEMA 12/IP54 powder coated alodined cast aluminum

Load Cell: Standard 350  $\Omega$  Bridge

Indicators: LO BATT, PEAK, MOTION, Center of ZERO, NET, GROSS, TOTAL, X1000, kg/lb, StPt1, StPt2

Function buttons:

POWER: Turns scale on and off

ZERO: Zeros applied load up to 100% of capacity

TARE: Tare In stores current GROSS weight as TARE. All subsequent readings are Net Weight. Tare Out returns the weight display to GROSS Mode

USER: Programmable multifunction button for use as TEST, TOTAL, UNIT, PEAK, NET/GROSS

Front panel calibration switch (located behind seal screw):  
 Initiates full digital calibration procedure

User button options:  
 TEST (default), TOTAL, UNIT, PEAK, NET/GROSS, OFF

**Auto Zero Tracking:**

Standard, can be disabled internally

**Auto-Off Mode:** Prolongs battery life by turning POWER off after 12 minutes or one hour (operator determined) of no scale activity

**Auto-Sleep Mode:**

Prolongs battery life by dimming LED display after one minute of no activity

**Unit:** kg, lb (other Units available with custom calibrations)

**Filtering:** Selectable: Low (LO), Medium (HI-1), High (HI-2)

**Totalization:** Standard: Press button or Automatic; TOTAL weight up to 99999 X 1000 kg or lb

**Peak:** Uses unfiltered faster reading of A/D

**Set Points:** Two internal standard Set Points and two ultra-bright LEDs on indicator panel

**Service Counter:**

Two independent 24 bit registers; Register 1 updated each time weight exceeds 25% of capacity; Register 2 updated each time weight exceeds overload; when register 1 exceeds 99,999 or register 2 exceeds 1000, display reads "LCnt" for load cell counter; Test function shows the two readings in order

**Connectors:** Connections are made with PCB mounted terminal strips allowing easy upgrading. Cables are brought out through water tight fittings

**Infrared Remote Controller:**

Available by adding infrared transmitter; no modifications are required to the crane unit

All of these features are housed in a single, low-profile, cast aluminum housing consisting of three sections:

- 1) The front of the scale houses the display, controls and all necessary electronics.
- 2) The center section contains the load cell, lifting eye and hook.
- 3) The rear of the scale features a quick access battery compartment.



**WARNING:** The scale has a safe mechanical overload of 200%, and an ultimate overload of 500%. Overloads greater than 500% may result in structural failure and dropped loads. Dropped loads may cause serious personal injury or death.

## FEATURES

- Designed to meet or exceed US and International Standards.
- Up to 100 hours of weighing time utilizing Automatic Sleep Mode.
- Automatic Power Off conserves battery life by sensing no activity after 12 minutes or one hour, determined by operator, and turns Power off.
- Automatic Sleep Mode preserves battery life by dimming the LED display after one minute of no activity.
- Rugged construction throughout. Buttons are sealed and rated for over 1 million operations.
- Precise high resolution (2500 division standard and up to 10,000 possible) 20 bit A/D conversion coupled with advanced 16 bit micro controller provides world class features and accuracy.
- Five large, 1.2 inch LED digits for clear weight readings from a distance.
- Easy to maintain: Full digital calibration assures reliable, repeatable measurements.
- Selectable for kgs/lbs; unless prohibited by regulations.
- Automatic or manual weight totalization for loading operations.
- Easily customized for special applications.
- PEAK Mode for stress analysis.
- Two Set Points can be set for any in-range weight for operator alerts or process control.

The LED display provides excellent readability from full sunlight to total darkness.

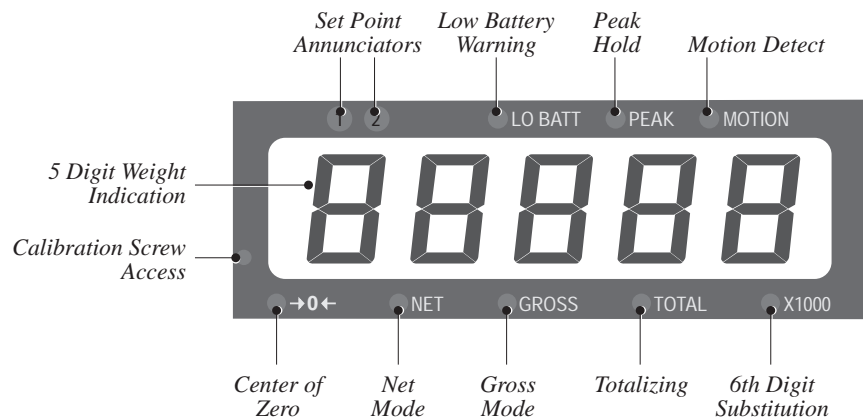

**Light Emitting Diode Display**

*In the event of an overload condition, the display will flash a warning to the operator.*

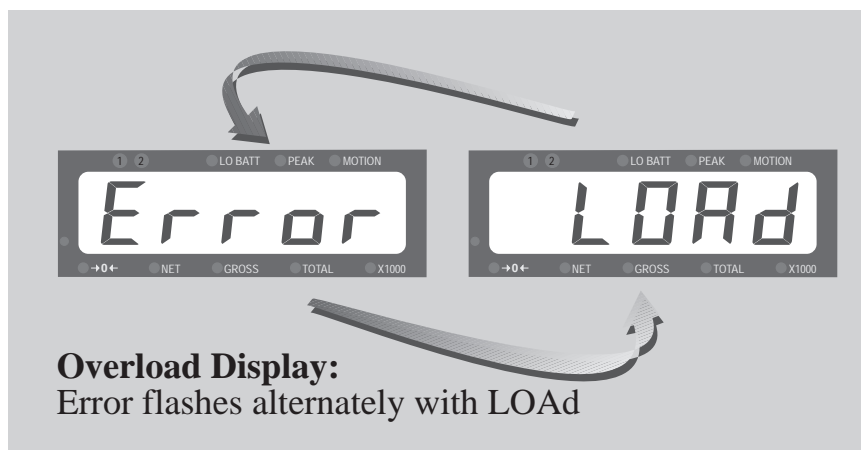

---

## OPTIONS

Options which you may have ordered with your Challenger 2 may include the following:

- Infrared Remote Controller.
- 115 or 230 VAC input power.

---

## UNPACKING

When unpacking the scale from the shipping container, ensure that all assembly parts are accounted for. Check the scale for any visible damage and immediately report any damage to your shipper. It is advisable to use the original shipping container when shipping or transporting the Challenger 2.

---

## ASSEMBLY

Identify and locate the following (see MSI-3360 assembly parts drawing):

1. Battery pack
2. Cotter pin
3. Load cell
4. Hook clevis assembly
5. Clevis pin

MSI-3360 Assembly  
Parts drawing.

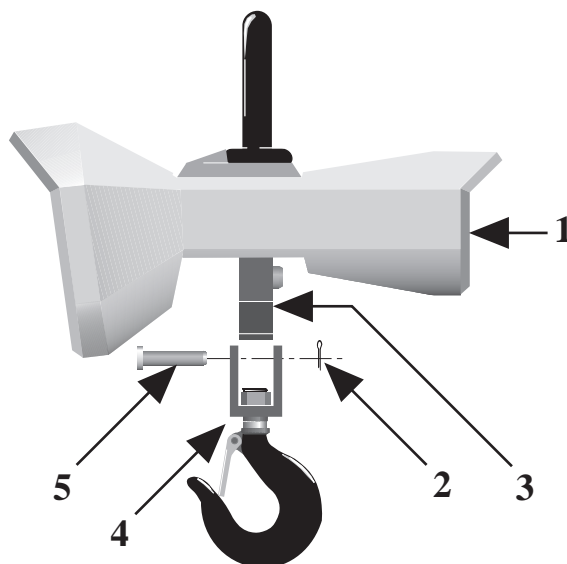

- 1) Slide hook clevis over load cell with open end of hook toward front of scale.
- 2) Align holes of clevis and load cell.
- 3) Slide the clevis pin through the clevis and load cell holes.
- 4) Lock clevis pin in place with cotter pin. Bend cotter pin.



**WARNING:** Scale will be unsafe for use if clevis pin is not properly secured with the cotter pin.

- 5) Slide battery pack into battery compartment. The battery will automatically engage with its connectors.
- 6) Secure battery pack by turning the two locking fasteners on access door clockwise 1/4 turn.
- 7) The scale is now ready for use.

---

## BATTERY PACK

The Challenger 2 is powered by a six volt rechargeable battery. The battery is permanently attached to the battery door.

To remove the battery pack, turn the two fasteners on the access door counter-clockwise 1/4 turn, then pull the battery pack straight out. The battery will automatically disengage from its connectors.

*Battery pack installation  
and removal*

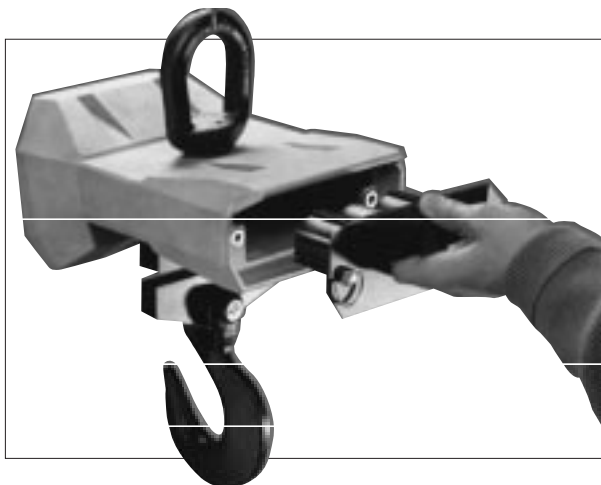

The battery will operate for up to 100 hours (depending on LED brightness setting) before requiring recharging. In order to conserve battery life, the scale includes an Automatic Power Off Mode which senses operational status for no activity after 12 minutes or one hour, and turns the scale off. An additional battery saving feature is the Automatic Sleep Mode. This feature preserves battery life by dimming the display after 1 minute of no scale activity. Charging time for a completely discharged battery is approximately 16 hours. A spare battery pack is recommended to keep the Challenger 2 in continuous operation.

**Note:** To obtain maximum service life from your batteries they should be stored between -4°F and 122°F (-20°C and +50°C). Stored batteries should be recharged every three months. Battery is fully charged when the status indicator is flashing.

---

## BATTERY CHARGER

- 1) Remove the battery from the scale.
- 2) Plug battery charger into an AC power receptacle of the same voltage and frequency stamped on the plug-in module.
- 3) Slide the battery charger connector plate over the top of the battery until the battery terminals mate with the charger connectors, as seen through the two observation holes.
- 4) Approximately 16 hours is required to recharge a fully discharged battery.

*Shown is the charger and battery assemblies.*

*Note that a second battery is recommended to enable you to use your scale continuously.*

*Keep one on the charger while the other is in service.*



**Note :** To obtain maximum service life from your batteries, the manufacturer suggests recharging after each 20 hours of use. Continuous deep discharging will inhibit maximum battery life cycle estimated at 2000 cycles.

## OPERATION GUIDE

Challenger 2 operation is controlled by four push buttons located below the display window.

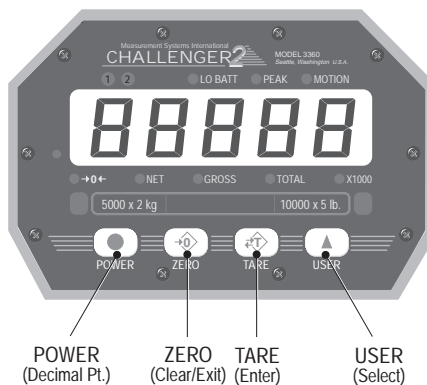

**Activating the push buttons with a sharp object, such as a screwdriver may cause permanent damage or broken seals.**

The four push button functions are as follows:



### Function

Turns the scale on/off (toggle action).

### Use

- 1) The battery pack must have enough charge to ensure accurate operation (>5.4V).
- 2) Ambient temperature must be greater than -30°C and less than 60°C (-22°F to 140°F).

### Action

- 1) Press **POWER** and hold for one second.
- 2) Display check: All segment and indicator LED's are illuminated for one second.
- 3) Numerics display the software version number for one second.
- 4) Any weight on the scale up to 5% of capacity will be automatically zeroed.
- 5) During display test, all internal operations are checked and any non-conformance causes an Error message display.

### Final

Scale reads the current weight in the last set Mode (NET, GROSS, PEAK NET, PEAK GROSS).



### Function

Sets scale to ZERO.

### Use

- 1) The scale must be stable. The scale will not ZERO if the motion detect indicator is on.
- 2) The scale must be in the GROSS Mode. The scale will not ZERO in NET Mode.
- 3) The scale will accept a ZERO setting over the full range of the scale (Legal For Trade models might have a limited ZERO range). ZERO settings greater than 5% of capacity will subtract from the overall capacity of the scale.

### Action

- 1) Press **ZERO**. The weight reading must be stable within  $\pm 1$  division. If this condition is met, the digits display "0" (or "0.0" or "0.00", depending on resolution).

- 2) The ZERO setting is stored in backup memory, and the setting will be restored the next time the scale is turned on.

### Final

GROSS indicator is illuminated and display will be "0" (or "0.0" or "0.00", depending on resolution).

TARE



### Function

TARE IN - Stores a TARE weight when in GROSS Mode and displays all subsequent readings in NET Mode;

or,

TARE OUT - Clears the TARE weight when in NET Mode and returns the scale to GROSS Mode.

### Action

TARE IN

- 1) Press **TARE** .
- 2) The scale must be in GROSS Mode: The entire range of the scale can be tared.
- 3) The Motion indicator must be off and the weight reading must be stable. (The weight reading must be stable within  $\pm 1$  division).
- 4) If the Motion condition is met, the NET indicator lights and the weight registers "0". All subsequent readings are deviations from the set TARE value.
- 5) Only positive weight readings can be tared.
- 6) Setting or changing TARE has no effect on the ZERO setting.
- 7) Tareing will reduce the apparent overrange of the scale. For example, if a 1000 lb container is tared and the scale capacity is 5000 lb, the scale will overload at a new weight of 4000 lb (5000 - 1000) plus any additional allowed overload (usually 9 divisions).
- 8) TARE value is stored in backup memory, and the value will be restored the next time the scale is turned on.

TARE OUT

- 1) The scale must be in NET Mode.
- 2) Press **TARE** to clear the value.
- 3) Returns to GROSS Mode.

### Final

TARE IN

TARE is set, displaying NET weight.

TARE OUT

TARE weight will be cleared and the scale will revert to GROSS Mode.



**Function**

USER can be programmed to any of five functions: TEST (tEst), NET/GROSS (nEtGr), TOTAL(totAL), UNIT(kg/lb) and PEAK(Phold). See Scale Setup for instructions on programming the USER button.

**Action**

Press **USER** to initiate the preprogrammed function.

TEST (tEst)

**Function**

Provides a functional system test, and an on-demand display check without disturbing the current weightment. Also provides calibration verification in the form of a load cell CAL number.

**Action**

- 1) Press **USER** (USER button must be programmed as test (see Scale Setup)).
- 2) Battery condition is displayed in Percent of battery life remaining with b = xxx figure from 0 to 100 on the digits (in 5% increments).
- 3) All segments and indicators are displayed for 3 seconds.
- 4) The CAL number is displayed next. To ensure that the CAL number is accurate the scale must be unloaded. Cal number shifts of up to 10 counts are insignificant.
- 5) All digits (7 segment and 16 segment) count once from 0 to 9. All indicators are tested.
- 6) Internal tests are performed to further ensure scale integrity.

**Final**

The reading returns to the last condition, or an Error message is displayed.



*Battery condition in percent remaining . . .*

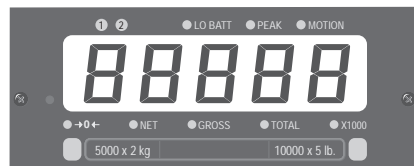

*all segments & indicators are displayed for 3 seconds . . .*

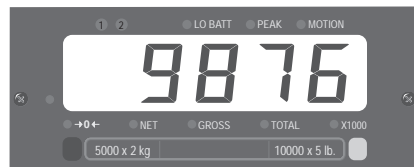

*CAL number is displayed . . .*

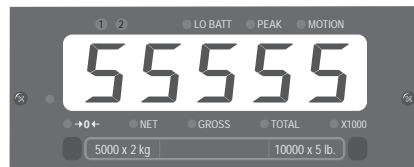

*and all digits count once from 0 to 9.*

## ACCESSING THE SERVICE COUNTERS

### Function

Challenger 2 maintains two service counters for safety, and two service counters that monitor internal electronics. These Service Counters are used to judge when the load bearing elements or electronic components should be inspected.

### Action

- 1) To access the Service Counters, program the USER button to TEST (tEST).
- 2) Press **TEST** and hold until the display reads "LCnt1" (Load Counter #1). This will occur after the RCAL value has been displayed. "LCnt1" will be displayed for 1 second, followed by a flashing numeric value. This value signifies the number of weighments that exceeded 25% of capacity.
- 3) Press **TEST**, "LCnt2" (Load Counter #2) will be displayed for one second, followed by a flashing numeric value. This value signifies the number of weighments that surpassed capacity.
- 4) Press **TEST**, "A2DEr" (A2D Errors) will be displayed for one second, followed by a flashing numeric value. This value signifies the number of times the internal microprocessor has reset the analog to digital converter.
- 5) Press **TEST**, "EE Er" (EEPROM Errors) will be displayed for one second, followed by a flashing numeric value. This value signifies the number of retries needed to successfully read from or write to the long term memory module.
- 6) Press **TEST** again to complete the TEST sequence.

### Final

TEST sequence continues.

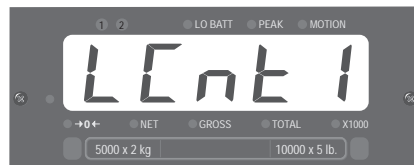

*LCnt1 will be displayed for 1 second followed by . . .*

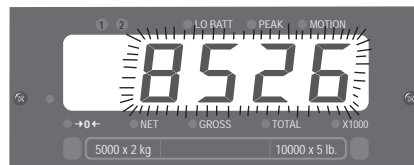

*a flashing total of "over 25%" weighments.*



*LCnt2 will be displayed for 1 second followed by . . .*

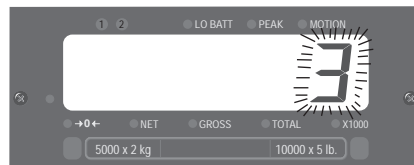

*a flashing total of "over capacity" weighments.*

---

## TO RESET THE SERVICE COUNTER WARNING

- 1) After inspecting the load train, remove the calibration seal screw.
- 2) Push the Calibration button using a blunt screwdriver.
- 3) Push **ZERO** to return to normal operation

Note: This procedure does not reset the service counter.

---

## TOTAL (TOTAL)

### Function

For accumulation of multiple weighments. The accumulator always uses the displayed weight, so GROSS and NET readings can be added into the same TOTAL. There are two Modes of totalizing: Manual and Auto. The Manual Mode requires the TOTAL button be pressed with the weight on the scale. The weight will be added to the previously accumulated value. The Auto Mode will automatically add the last settled and stable value to the TOTAL. Both Modes require that the weight on the scale return within 1% (relative to full scale) of GROSS ZERO or NET ZERO before the next weighment can be added. This assures that a weight on the scale is only added to the total once. Applied weight must be 2% of full scale above GROSS ZERO or NET ZERO before it can be totaled.

---

## MANUAL TOTAL

### Function

Allows for accumulating weight manually by pressing a button.

### Use

- 1) The Motion indicator must be off, the scale must be stable  $\pm 1$  division. If there is considerable motion on the scale, use the Medium or High Filter setting (see Filter Setup). The scale will accept the TOTAL button when in motion, but will not TOTAL until the Motion indicator is off.
- 2) Only positive readings can be accumulated.
- 3) After a weight is totaled, the weight on the scale must return below 1% of full scale capacity relative to GROSS ZERO or NET ZERO before another weight can be added to the TOTAL. This assures that a weight on the scale is only added to the scale once.
- 4) Press **USER** (USER button must be programmed as TOTAL (see Scale Setup).
- 5) If the Motion indicator is on, the TOTAL indicator will begin blinking,

and continue blinking, until motion stops and the Motion indicator turns off. The current weight is added to the TOTAL register and the TOTAL weight is displayed.

- 6) The TOTAL indicator (center right of display) will also illuminate for 4 seconds providing reinforcement that the TOTAL command was accepted.

#### **Final**

After totaling, normal weighing resumes.

## AUTO TOTAL

### **Function**

Allows for Auto accumulate.

### **Use**

- 1) When a weight threshold of 2% of Full Scale (FS) above NET ZERO or GROSS ZERO is exceeded, the accumulate function operates automatically.
- 2) When a weight that meets the minimum acceptable limit settles (no Motion), the TOTAL indicator will flash 3 times.
- 3) If the weight changes to a new settled value the TOTAL indicator will flash again indicating the previous settled reading has been replaced.
- 4) When a weight is totaled, the TOTAL indicator will flash for a steady 4 seconds, indicating the weight has been totaled and the TOTAL value will be displayed.
- 5) The displayed weight is added to the accumulated value in the TOTAL Register only when the weight returns to ZERO ( $\pm 1\%$  of Full Scale).
- 6) The last settled reading is what will be used for totalizing when the scale returns to ZERO.



**WARNING:** The operator must take caution that, when removing the load, the scale does not go out of Motion; or an erroneous reading could occur. The last settled weight is actually added to the TOTAL when the scale returns to less than 1% of full Scale capacity.

### **Action**

- 1) The scale cannot be in motion. An Auto TOTAL acceptable reading is indicated by 3 or more short flashes of the TOTAL indicator.
- 2) Weight readings must be greater than 2% of full scale, relative to NET ZERO or GROSS ZERO.
- 3) Each reading added to TOTAL must be preceded by a return to ZERO (NET or GROSS)  $\pm 1\%$  of full scale. Totalization of the last settled weight is indicated by a 4 second flash of the TOTAL indicator, and a

display of the current TOTAL.

**Final**

After totaling, normal weighing resumes.

---

## TO CLEAR THE LAST TOTALED WEIGHT

**Function**

If the last totaled (automatic or manual) weight was a mistake, it can be erased with the following procedure. This erases only the last totaled value.

**Action**

- 1) Press **USER** , then **ENTER(TARE)** . The display will read the revised TOTAL for 2 seconds. (This procedure assumes that you have not modified the USER function.)

**Final**

After displaying the update TOTAL, normal weighing resumes.

---

## TO CLEAR THE TOTAL VALUE

**Function**

To clear the TOTAL register in order to start a new series of totals.

**Action**

- 1) Press **USER** , then **CLEAR(ZERO)** . (This procedure assumes that you have not modified the USER function.)
- 2) The display reads "0" and the TOTAL indicator will illuminate for 2 seconds.

**Final**

After clearing the TOTAL, normal weighing resumes.

---

## VIEWING TOTAL

**Function**

After a weight has been totaled or before the 1% threshold has been exceeded, the current TOTAL can be Viewed.

**Action**

- 1) Make sure there is no load on the scale. Press **USER** (USER button must be programmed as TOTAL).
- 2) The current TOTAL will be displayed for 3 seconds. The TOTAL indicator will illuminate.

**Final**

Normal weighing resumes.



**Caution:** If in Manual TOTAL and you push the TOTAL button to view the TOTAL value, be certain that you are not weighing more than 2% of capacity. (If you press USER to view the TOTAL and the weight is above 2% of capacity, you will add to the TOTAL, rather than view the TOTAL.)

## UNIT (kg/lb)

### Function

To change unit between kg/lb.

### Action

- 1) Press **USER** to select kg or lb Mode (USER must be programmed as Unit; see USER Setup). The kg and lb indicators are located on the front panel adjacent to their relative capacity labels.

### Final

The correct unit of measurement/weight is displayed.

Alternate Method: Use the Setup UNITS Mode to change the UNITS without programming USER to UNITS.

## PEAK (Phold)

### Function

Allows the capture of a PEAK weight. Useful for stress testing and related operations where the maximum load measured is stored.

### Action

- 1) Press **USER** (USER button must be programmed as PEAK(Phold); see USER Setup).
- 2) To enable PEAK(Phold), the PEAK indicator must be off.  
Press **USER** .
- 3) To disable PEAK(Phold) the PEAK indicator must be on.  
Press **USER** .

### Final

- 1) When enabled, the PEAK(Phold) value is reset to 0 and any subsequent displayed value will correspond to the greatest positive weight detected.
- 2) When PEAK(Phold) is disabled the scale will perform normally.

---

## NET/GROSS (nEtGr)

### Function

Switches the display between NET and GROSS Modes. NET Weight is defined as GROSS Weight minus a TARE Weight.

### Use

- 1) There must be a TARE weight established to switch from GROSS Mode to NET Mode (see TARE).
- 2) NET GROSS(nEtGr) will work even when the scale is in Motion.

### Action

- 1) Press **USER** (USER button must be programmed as NET GROSS (nEtGr), see USER Setup).
- 2) No current TARE is stored (TARE =0). No action, display continues to read the Gross weight only.
- 3) A TARE value is stored: Toggles between NET and GROSS indicators.

### Final

NET or GROSS indicator will illuminate.

---

## SCALE SETUP

### Function

Scale Setup facilitates changes to various internal settings of the scale. Setup is initiated by holding in the USER button while turning POWER on.

### Action

When in SETUP, the following buttons are used for selecting and changing scale settings:

ZERO functions as CLEAR/EXIT: Used to exit from a Setup menu without affecting the previous setting and for exiting Setup Mode completely. Used also to clear the current digit when entering numeric values; i.e., Set Points.  
TARE functions as ENTER: Used to enter into menus and choose menu items.

USER functions as SELECT: Used to scroll through menu selections. If held down, SELECT will automatically repeat.

POWER functions as Decimal Point: Used for entering a decimal point in displayed values (i.e. Tare or Setpoint).

### Final

Pressing **CLEAR(ZERO)** will skip all remaining parameters and return the scale to normal operation. Pressing **POWER** will also exit the Setup Mode (and turn Power off).

QUICK USER SETUP GUIDE

Note: Display items in **bold** are defaults.

Top Menu	Selection Display	Sub-Menu	Display Definition
Func	OFF <b>tEst</b> totAl Unit Phold nEtGr		Function Off Test Total Unit Peak Hold Net/Gross
A-OFF	<b>OFF</b> .2 hr 1 hour		Automatic Power Off Off 12 minutes 1 hour
Filtr	<b>LO</b> HI-1 HI-2		Filter Low Medium High
LEdS	Auto LO <b>HI-1</b> HI-2		Light Emitting Diodes Automatic Low Medium High
Unit	Unit(kg) <b>Unit(lb)</b>		Units Kilograms Pounds
StPt1	<b>OFF</b> GrEAt LESS	LESS,GrEAt followed by value	Set Point 1 Off Greater than Less Than
StPt2	<b>OFF</b> GrEAt LESS	LESS,GrEAt followed by value	Set Point 2 Off Greater Than Less Than
totAL	<b>OFF</b> PrESS Auto		Total Off Press User Button Automatic Total

---

## FUNCTION (Func)

### Function

Allows the USER button to be programmed to TEST, TOTAL, UNIT, NET/GROSS or PEAK

### Action

- 1) Hold in the **USER** button while turning on the power.
- 2) Press **SELECT(USER)** until the display reads "Func".
- 3) Press **ENTER(TARE)** and currently selected function will flash.
- 4) Press **SELECT(USER)** until desired function is displayed.
- 5) Press **ENTER(TARE)** to store or press **CLEAR(ZERO)** to exit without changing.

### Final

Setup menu is displayed. Press **CLEAR(ZERO)** to return to normal operation or press **SELECT(USER)** to scroll to a different USER Setup operation.

---

## AUTOMATIC POWER OFF (A-OFF)

### Function

The A-OFF feature, when enabled, prolongs the battery life of the scale by turning POWER off when the scale is not in use. Any time a button is depressed (any button), or the detected weight is in Motion, the time limit is reset. Therefore, the scale will stay on indefinitely if the weight is changing or any button is pressed at least once. With A-OFF disabled, the scale will remain on; only pressing POWER will turn it off.

### Action

To Change the A-OFF Mode:

- 1) Hold in the **USER** button while turning on the power.
  - 2) Press **SELECT(USER)** until the display reads "A-OFF".
  - 3) Press **ENTER(TARE)** . You are now in the A-OFF menu.
  - 4) Press **SELECT(USER)** to choose: OFF, .2 hours (12 minutes), or 1 hour.
- When the desired Mode is displayed, press **ENTER(TARE)** or press **CLEAR(ZERO)** to exit without changing.

### Final

USER Setup menu is displayed. Press **CLEAR(ZERO)** to return to normal operation or press **SELECT(USER)** to scroll to a different USER Setup operation.

---

## FILTER (Filtr)

### Function

Allows three levels of filtering to stabilize readability of the weight display.

### Use

- 1) Use LO (low setting), for most scale applications. It settles fastest and is intended for general use.
- 2) Use HI-1 (medium setting), when the scale is being used under conditions that cause light to medium swinging.
- 3) Use HI-2 (high setting), when there is significant scale motion. There is a time penalty when using the HI-2 setting. The operator should wait at least 5-15 seconds to ensure that the final reading has settled (motion indicator off). (Not available in some Legal For Trade scales).

### Action

To change the Filter settings:

- 1) Hold in the **USER** button while turning on the power.
- 2) Press **SELECT(USER)** until the message reads "Filtr".
- 3) Press **ENTER(TARE)**. The currently selected filter will flash.
- 4) Press **SELECT(USER)** to change from LO (low), HI-1 (medium) or HI-2 (high) settings. When the desired Filter setting is displayed on the message display, press **ENTER(TARE)** or press **CLEAR(ZERO)** to exit without changing the setting.

### Final

Setup menu is displayed. Press **CLEAR(ZERO)** to return to normal operation or press **SELECT(USER)** to scroll to a different USER Setup operation.

---

## LED BRIGHTNESS (LEdS)

### Function

Sets the LED brightness to one of three fixed settings; or to an automatic setting that adjusts brightness according to ambient light, and also adjusts to the lowest level of brightness when the scale is inactive for 1 minute (Automatic Sleep Mode). Automatic Sleep Mode is recommended for minimizing battery consumption.

### Action

- 1) Hold in the **USER** button while turning on the power.
- 2) Press **SELECT(USER)** until "LEdS" is displayed.
- 3) Press **ENTER(TARE)** and currently selected brightness will flash.
- 4) Press **SELECT(USER)** to change from AUTO, LO, HI-1 or HI-2 settings.
- 5) Press **ENTER(TARE)** to store, or press **CLEAR(ZERO)** to exit without

changing.

#### **Final**

Setup menu is displayed. Press **CLEAR(ZERO)** to return to normal operation or press **SELECT(USER)** to scroll to a different USER Setup operation.

Note: To maximize battery life, set the LED to the Automatic Sleep Mode.

## UNIT (kg/lb)

#### **Function**

Allows Units to alternate between kg and lb without the use of the USER button.

#### **Action**

- 1) Hold in the **USER** button while turning on the power.
- 2) Press **SELECT(USER)** until "Unit" is displayed.
- 3) Press **ENTER(TARE)**. The display will show "Unit" while the indicator which correlates to the currently set Unit (kg or lb) will flash.
- 4) Press **SELECT(USER)** until desired Unit (kg or lb) is displayed.
- 5) Press **ENTER(TARE)** to store, or press **CLEAR(ZERO)** to exit without changing.

#### **Final**

Setup menu is displayed. Press **CLEAR(ZERO)** to return to normal operation or press **SELECT(USER)** to scroll to a different USER Setup operation.

Alternate Method: Program the USER button as UNITS.

## SETPOINTS (StPt1, StPt2)

#### **Function**

Set Points provide warnings and indications of weighments. When the weight is above (greater than) or below (less than) a set value, the Challenger 2 can respond by turning on the Set Point indicator light.

## SET POINT ENTRY

#### **Function**

To enter a Set Point.

#### **Action**

- 1) Hold in the **USER** button while turning on the power.

- 2) Press **SELECT(USER)** to choose the Set Point you wish programmed. Set Point 1 will be used for this example.
- 3) When the display reads "StPt1" press **ENTER(TARE)**.
- 4) Determine if the Set Point will be active when the weight is above ("GrEAt") or below ("LESS") the entered value. Press **SELECT(USER)** to choose the mode. For an overload alarm, for example, you would choose greater. Press **ENTER(TARE)**.
- 5) The current Set Point value will flash.
- 6) Press **SELECT(USER)** to enter the first digit of the desired Set Point weight value (Value cannot exceed scale capacity). Press **ENTER(TARE)**.

Note: Press **POWER** to enter a decimal point.

- 7) The next significant digit flashes. Press **SELECT(USER)** to enter the next digit. Press **ENTER(TARE)** twice after the last character to complete the Set Point entry.

#### **Final**

Setup menu is displayed. Press **CLEAR(ZERO)** to return to normal operation or press **SELECT(USER)** to scroll to a different USER Setup operation.

## TO DISABLE A SET POINT

#### **Function**

To turn off a Set Point.

#### **Action**

- 1) Hold in the **USER** button while turning on the power.
- 2) Press **SELECT(USER)** to identify the Set Point you wish to disable. Set Point 1 will be used for this example.
- 3) When the display reads "StPt1" press **ENTER(TARE)**.
- 4) Press **SELECT(USER)** until the message "OFF" appears. Press **ENTER(TARE)**. This disables the Set Point and returns you to the Set Point menu.

#### **Final**

Setup menu is displayed. Press **CLEAR(ZERO)** to return to normal operation or press **SELECT(USER)** to scroll to a different USER Setup operation.

---

## TOTAL (total)

### Function

Allows the TOTAL function to be set or disabled. The USER button must be programmed to TOTAL in order to view the current TOTAL value, or to use Manual TOTAL.

### Action

- 1) Hold in the **USER** button while turning on the power.
- 2) Press **SELECT(USER)** until "totAL" is displayed.
- 3) Press **ENTER(TARE)** and the currently selected total mode will flash.
- 4) Press **SELECT(USER)** until the desired TOTAL Mode — OFF, PrESS (manual), or AUTO (automatic) is displayed.
- 5) Press **ENTER(TARE)** to store, or press **CLEAR(ZERO)** to exit without changing.

### Final

Setup menu is displayed. Press **CLEAR(ZERO)** to return to normal operation or press **SELECT(USER)** to scroll to a different USER Setup operation.

---

## SYSTEM INITIALIZE



**Caution:** Do Not Initialize the scale for routine calibration. System initialize is only needed when the circuit boards are replaced. This procedure should be initiated only by the factory or any authorized service representative.

### Function

Clears the internal Calibration settings. Usually used for board replacement, troubleshooting, or load cell replacement. This procedure does not alter factory feature settings.

### Action

- 1) Turn off the scale by pressing the **POWER** key.
- 2) Remove the seal port on the left front panel of the scale. Press the switch button in the hole with a probe, such as a blunt tip screwdriver, and simultaneously press the **POWER** key.
- 3) The scale will prompt the user for confirmation by displaying “SurE?”
- 4) Pressing **TARE** will continue the system initialization. Pressing **ZERO** will abort the system initialization without resetting any parameters.

---

## CALIBRATION SETUP

### Function

Calibration Setup is used to initiate calibration or to set seldom changed factory settings.

There are two types of calibration:

- 1) Initial Calibration; and
- 2) Subsequent Calibration

Calibration must be accomplished by a qualified Scale Technician trained in Certified Calibration Standards. To initiate calibration of a Challenger 2, the Technician is required to have an accurate test weight system of adequate capacity and, in the case of a Legal For Trade Challenger 2, the test weight system must be certified by the appropriate regulatory agency.

**Important Note:** At any point (except when entering calibration weight values), the calibration procedure can be halted by turning POWER off.

### Action

- 1) Remove the seal port on the left front panel of the scale. Insert a probe, such as a blunt tip screwdriver, to depress the underlying button. The display will show "C-SEt" for 1 second.
- 2) The Calibration Setup Menu appears. Press the **SELECT(USER)** button to scroll through the various Calibration Setup menu choices.
- 3) Once the desired operation is displayed, press **ENTER(TARE)**.

### Final

To return to normal operation either scroll with the **SELECT(USER)** button to exit and press **ENTER(TARE)**, or press **CLEAR(ZERO)**.

## QUICK CALIBRATION SETUP GUIDE

*Note: Display items in **bold** are defaults.*

Top Menu	Selection Display	Display Definition
CAL		Calibration
F-CAL		Fine Calibration
CAL-r		Calibration with Offset Calibration Resistor
StAnd	<b>IndUS</b> nISt EuroP 1 Unit	Standards Industry National Institute of Standards & Technology Metric (kg only)/OIML One Unit Only
r-Ctl	On <b>OFF</b>	Remote Control
AZt	<b>On</b> Off	Automatic ZERO Tracking

## CALIBRATION (CAL)

### Function

Used to Calibrate the scale load cell. There are two types of calibration:

- 1) Initial Calibration and
- 2) Subsequent Calibration.

## INITIAL CALIBRATION

### Function

Initial Calibration is used at the factory when Calibrating for the first time, when the circuit boards have been replaced or after the scale has gone through System Initialize.

*Note:* Do not use this procedure for routine Calibration.

### Action

- 1) Press **SELECT(USER)** until "CAL" appears then press **ENTER(TARE)**. The following steps will occur:
- 2) Display flashes right hand lb. indicator while displaying number of lbs. if

calibrating in lbs. press **ENTER(TARE)**, or to select kgs (left hand kg indicator flashes) press **SELECT(USER)** then **ENTER(TARE)**.

**Note:** This step will not occur in scales equipped to measure in only one unit.

- 3) Display shows "CAP" for 2 seconds then flashes "0". Input the capacity using **SELECT(USER)** and **ENTER(TARE)**.
- 4) Display shows "d" for 2 seconds, then flashes the default Count By (division). Press **ENTER(TARE)** to accept, or press **SELECT(USER)** to pick another Count By, then press **ENTER(TARE)**.
- 5) Display flashes "GAIN4". Press **ENTER(TARE)** to accept, or press **SELECT(USER)** to pick another gain, then press **ENTER(TARE)**.

See Gain Table.

Capacity of Scale		Gain	Capacity of Scale		Gain
250 lb	125 kg	4	5,000 lb	2,500 kg	4
500 lb	250 kg	4	10,000 lb	5,000 kg	4
1,000 lb	500 kg	4	15,000 lb	7,500 kg	4
2,000 lb	1,000 kg	3			

*Gain Table*

- 6) Display flashes "UnLd". Unload the scale and press **ENTER(TARE)**. The scale will display "CALC", for calculating.
- 7) Display shows "LOAD" for 2 seconds then flashes the capacity. Load the scale with a test weight that is equal to capacity weight; or if the test weight is less than capacity, enter the actual weight of the test weight by pressing **SELECT(USER)** then **ENTER(TARE)**. After the last number of the weight has been entered and the motion indicator is off press **ENTER(TARE)**. The display will show "CAL'd" if successful, or "CErr" if not successful. An unsuccessful calibration can be due to an improper gain setting, or use of a calibration weight that is too light.
- 8) Display flashes "UnLd". Unload the scale and press the **ENTER(TARE)** button. Afterwards "r-CAL" will be displayed until the value is determined. If successful, then the CAL-r value is displayed for 10 seconds or until any button is pressed. If unsuccessful, the display will show "r-Err" for 2 seconds.

**Final**

Display shows "StorE" to signify that the calibration parameters are being saved in backup memory. When complete the display will show "F-CAL" for the next menu item. Press **CLEAR(ZERO)** to return to normal scale operation.

---

## SUBSEQUENT CALIBRATION

### Function

Subsequent Calibration is used for routine annual Calibration or when the scale is not weighing accurately.

### Action

- 1) To set ZERO the display flashes "UnLd". Unload the scale and press **ENTER(TARE)**. The scale will display "CALC" (for calculating).
- 2) To input the Calibration weight value the display will show "LOAD" for 2 seconds then flash the capacity. Load the scale with this weight or input another weight. After the last number of the weight has been entered and the motion indicator is off, press **ENTER(TARE)**. The display will show "CAL'd" if successful, or "CErr" if not successful. An unsuccessful calibration can be due to an improper gain setting, or use of a calibration weight that is too light.
- 3) To set the CAL-r value the display flashes "UnLd". Unload the scale and press the **ENTER(TARE)** button. Afterwards "CAL-r" will be displayed until the value is determined. If successful, then the CAL-r value is displayed for 10 seconds or until any button is pressed. If unsuccessful, the display will show "r-Err" for 2 seconds.

**Note:** It may be desirable to bypass a calibration step. To do so press **CLEAR(ZERO)**. The step bypassed will retain the default or last set value. However, bypassing a calibration step may result in an incomplete or inaccurate calibration.

### Final

Calibration is complete and the display shows "StorE" to signify that the calibration parameters are being saved in backup memory. When complete the display will show "F-CAL" for the next menu item. Press **CLEAR(ZERO)** to return to normal scale operation.

---

## FINE CALIBRATION (F-CAL)

### Function

Fine Calibration (F-CAL) is for minor adjustments to calibration and is usually not necessary. It is useful, however, in hydraulic calibration fixtures for fine adjustments.

**Action**

- 1) Press **SELECT(USER)** to scroll to the "F-CAL" message. Press **ENTER(TARE)**.
- 2) Pick up a test weight of (or set the hydraulic tension to) at least 25% of capacity. The weight is indicated on the numeric digits. The display will flash "LOAD" if the weight is under 25%.



**WARNING:** Fine Calibration will not function unless the scale is loaded at 25% of capacity or more.

- 3) Press **SELECT(USER)** to cause the displayed reading to move up slightly. Press the button **CLEAR(ZERO)** to cause the reading to move down. Each press of the **SELECT(USER)** or **CLEAR(ZERO)** button causes the calibration to shift by 1/4 displayed count. When the displayed reading is acceptable, press **ENTER(TARE)**.

**Final**

Fine Calibration is complete, press **CLEAR(ZERO)** to return to normal scale operation, or press **SELECT(USER)** to choose another Calibration Setup function.

## CALIBRATION WITH CALIBRATION OFFSET RESISTOR (CAL-r)

**Function**

Calibration with the Cal Resistor (CAL-r) is for emergency calibration only when test weights or a calibration system are not available.

**Action**

- 1) Press **SELECT(USER)** to scroll to the "CAL-r" message. Press **ENTER(TARE)**.
- 2) Display flashes "UnLd". Unload the scale and press **ENTER(TARE)**. The scale will display "CALC" (for calculating).
- 3) Display shows "LOAD" for 2 seconds then flashes last set CAL-r value. Input the CAL-r value printed on the load cell Cal Sheet. After the last number has been entered, press **ENTER(TARE)**. The display will show "CAL'd".
- 4) Display flashes "UnLd". Unload the scale and press **ENTER(TARE)**. Afterwards CAL-r will be displayed until the value is determined. Then the CAL-r value is displayed for 10 seconds, or until any button is pressed.

**Final**

Calibration is complete and the display shows "StorE" to signify that the calibration parameters are being saved in backup memory. The calibration

menu returns. Press **CLEAR(ZERO)** to return to normal operation or press **SELECT(USER)** to scroll to a different Calibration Setup operation.

**Note:** When Calibration is finished, seal the Calibration Port on the front panel of the scale.

## STANDARDS (StAnd)

### Function

Facilitates calibration to your required standard:

IndUS	Industrial
nISt	National Institute of Science and Technology (NTEP setting)
EuroP	Metric/OIML
1Unit	One Unit only (for custom scales)

### Action

- 1) Press **SELECT(USER)** until "StAnd" is displayed.
- 2) Press **ENTER(TARE)** and the currently selected standard will flash.
- 3) Press **SELECT(USER)** to choose desired standard.
- 4) Press **ENTER(TARE)** to store, or press **CLEAR(ZERO)** to exit without changing.

### Final

The calibration menu is displayed. Press **CLEAR(ZERO)** to return to normal operation or press **SELECT(USER)** to scroll to a different Calibration Setup operation.

## REMOTE CONTROL (r-Ctl)

### Function

Used to enable or disable the use of a Remote Control.

### Action

- 1) Press **SELECT(USER)** until "r-Ctl" is displayed.
- 2) Press **ENTER(TARE)** and currently selected Remote Control Mode (On/Off) will flash.
- 3) Press **SELECT(USER)** to choose ON or OFF.
- 4) Press **ENTER(TARE)** to store or press **CLEAR(ZERO)** to exit without changing.

**Final**

The Calibration menu is displayed. Press **CLEAR(ZERO)** to return to normal operation or press **SELECT(USER)** to scroll to a different Calibration Setup operation.



**Caution:** Do Not enable the Remote Control if the option was not purchased with the scale.

---

## AUTO ZERO TRACKING (AZT)

**Function**

To enable/disable AZt for certification testing.

**Action**

- 1) Press **SELECT(USER)** until "AZt" is displayed.
- 2) Press **ENTER(TARE)** and the currently selected AZt Mode (On/Off) will flash.
- 3) Press **SELECT(USER)** to choose the desired AZt Mode (On/Off).
- 4) Press **ENTER(TARE)** to store or press **CLEAR(ZERO)** to exit without changing.

**Final**

The Calibration menu is displayed. Press **CLEAR(ZERO)** to return to normal operation or press **SELECT(USER)** to scroll to a different Calibration Setup operation.



**Caution:** Disabling Auto Zero Tracking will degrade temperature and drift performance of the Challenger 2. Disabling the AZt is only intended for certification testing. Under no other circumstances should the Scale be used with AZt disabled.

INFRARED REMOTE OPTION

INTRODUCTION

The MSI IR Remote Controller option provides the user of the Challenger 2 Crane Scale complete remote control of all scale operation functions. In addition, a numeric keypad allows the operator easy entry of tare values and set-point values. Several features, which are only available on the Challenger’s “USER” key, are directly accessible on the IR Remote. These include “NET/GROSS”, “TOTAL”, “VIEW TOTAL”, and “SETUP”. Also, maneuvering in menus is simplified by the use of a “SETUP” key combined with “MENU UP” (USER), “MENU DOWN” (UNITS), “ENTER”, and “EXIT” (SETUP) keys.

The IR Remote is available for any Challenger 2 Crane Scale. The necessary Infrared Sensor and supporting firmware is standard and therefore no modification of the scale is necessary other than enabling the remote function.

**Features:**

- Reliable Infrared remote control of Power, Zero, Tare, etc.
- All scale functions are controllable from a distance of up to 25 feet (8 meters).
- Adds easy numeric keypad entry of Tare, Set-Points, and calibration constants.
- Adds full time “NET/GROSS” key.
- Adds full time “TOTAL” and “VIEW TOTAL (Σ)” keys for easy access to the totalize functions.
- Adds full time “UNITS” key.
- Allows full time “TARE” and adds full time “RECALL TARE” keys.
- Adds full time “SETPOINT 1” and “SETPOINT 2” keys.
- Display Brightness control.
- Easy access to Setup functions.

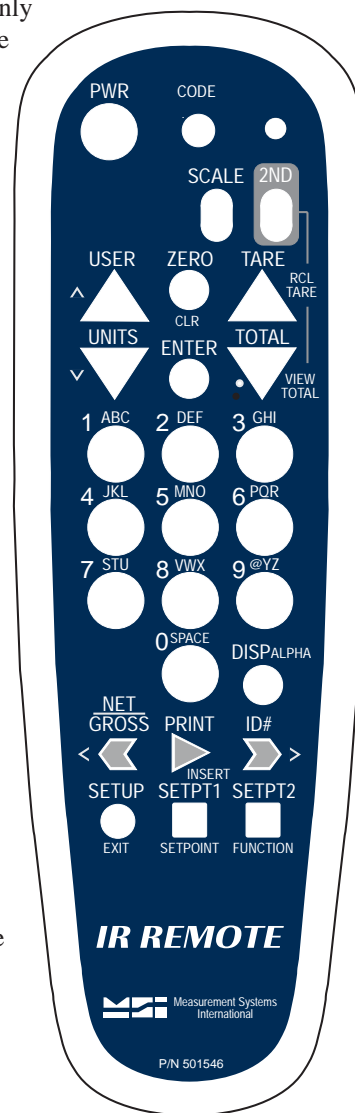

---

## REMOTE CONTROLLER OPERATION

In general, the IR Remote keys function the same as the front panel switches on the crane scale. The “ZERO”, “TARE”, and “USER” keys function the same as the front panel keys. The enhanced functions or any functional differences are detailed in the following sections.

The Infrared Sensor is located to the left side of the front panel. In general, the operator must aim the IR Remote unit directly at the front panel of the scale. As distance increases accurate aiming becomes more critical. The IR Remote will not function in direct sunlight, and will have very limited range outdoors.

---

## TO ENABLE REMOTE CONTROLLER

### Function

Used to enable the Remote Controller. This procedure is performed directly on the scale, not on the IR Remote.

### Procedure

- 1) Remove the seal port on the left front panel of the scale. Insert a probe, such as a blunt tip screwdriver, to depress the underlying button. The display will show "C-SEt" for 1 second.
- 2) Press **SELECT(USER)** until "r-Ctl" is displayed.
- 3) Press **ENTER(TARE)**. The currently selected Remote Control Mode (On/Off) will flash.
- 4) Press **SELECT(USER)** to choose ON.
- 5) Press **ENTER(TARE)** to store. The menu will change to "AZt".
- 6) Press **CLEAR(ZERO)** to return to normal operation.

### Final

The IR Remote is now enabled.



**Caution:** Do Not enable the Remote Control if the option was not purchased with the scale.

---

## BATTERIES

The IR Remote requires two standard ‘AAA’ cells. Battery life will depend on the frequency of use, but could last up to a year. Anytime the batteries are changed, the IR Remote Access Codes must be programmed.

---

## TO SET REMOTE CONTROLLER ACCESS CODES

The IR Remote contains internal access codes that must be programmed to function with the Challenger 2. This procedure must be followed after changing batteries:

- 1) Press and hold the **CODE** button until the indicator light goes on, then release the **CODE** button.  
Press and release the **2ND** button.  
Press and release the **1** button.  
Press and release the **4** button.  
Press and release the **8** button.  
The indicator light will go out.
- 2) Press and hold the **CODE** button until the indicator light goes on, then release the **CODE** button.  
Press and release the **SCALE** button.  
Press and release the **0** button.  
Press and release the **0** button.  
Press and release the **9** button.  
The indicator light will go out.

The IR Remote is now ready for use.



**WARNING:** If the access codes are not properly set, the IR Remote might fail to function or will function erratically. Always reset the access codes after changing batteries.

---

## THE SCALE AND 2ND KEYS

The Challenger IR Remote has two modes of operation.

- 1) Pressing the **SCALE** key defines the IR Remote keys to the light grey commands. For example, after pressing the **SCALE** key, the VIEW TOTAL and RECALL TARE functions are unavailable. Active: PWR, USER, ZERO, TARE, UNITS, ENTER, TOTAL, 0-9, DISP, NET/GROSS, SETUP, SETPT1, SETPT2.
- 2) Pressing the **2ND** key defines the IR Remote keys to the green commands. For example, after pressing the **2ND** key, the VIEW TOTAL and RECALL TARE keys are active while many other remote controller keys are inactive. Active: PWR, USER, RECALL TARE, UNITS, ENTER, RECALL TOTAL.

---

## POWER

### To turn on the Scale:

- 1) Aim the IR Remote at the Challenger front panel.
- 2) Press and hold down the **POWER** key until the Challenger turns on. Once the display lights up, release the button. This usually takes 2 to 4 seconds.

### To turn off the Scale:

- 1) Aim the IR Remote at the Challenger Front Panel.
- 2) Press the **POWER** key. The Challenger will turn off immediately.

See User Guide page 11 for more POWER key information.

---

## ZERO

See User Guide page 11.

---

## TARE

See User Guide page 12.

---

## RECALL TARE

To view the currently stored tare value, press the **2ND** button and then press the **RCL TARE** button. Don't forget to press the **SCALE** button to reactivate the main IR Remote key functions.

---

## NET/GROSS

The NET/GROSS function is available on the Challenger 2 as a USER key function. The Remote provides this function full time through the use of the NET/GROSS key. See User Guide page 19 for more detail on NET/GROSS.

---

## USER

The USER key is programmable to any of five functions: TEST, NET/GROSS, TOTAL, UNIT, and PEAK. If you are making regular use of the Remote, there

is no need to set the USER key to NET/GROSS, UNITS or TOTAL, as these keys are available full time on the Remote unit. However, there is no harm in having duplicated functions on the USER key if you so desire. See “Scale Setup” for instructions on programming the USER button.

---

## UNITS

The UNITS function is available at power up or by programming the USER key to change between pounds and kilograms. The IR Remote provides this function full time by pressing the **UNITS** key. See User Guide page 23 for more information on UNITS.

---

## TOTAL

The Total function is available full time on the Remote rather than just a USER key function. See User Guide page 15 for more details.

*Note:* When the Challenger 2 is set up for AUTO total, the TOTAL key has no function.

---

## VIEW TOTAL (VIEW $\Sigma$ )

### Function

The VIEW  $\Sigma$  key gives the user immediate access to the Total Register.

### Operation

- 1) Aim the IR Remote at the Challenger Front Panel.
  - 2) Press the **2ND** key.
  - 3) Press the **VIEW $\Sigma$**  key. The TOTAL LED will light, and the Total weight will appear on the numeric digits for 4 seconds.
  - 4) Don't forget to press the **SCALE** key to reactivate the main IR Remote key functions.
- 

## CLEAR LAST TOTAL

### Function

The user may clear the last totaled weight from the Total Register.

### Operation

If the USER key is programmed to “Total” then:

- 1) Aim the IR Remote at the Challenger Front Panel.
- 2) Press the **USER** key.
- 3) Press the **TARE** key.

If the USER key is not programmed to “Total” then:

- 1) Aim the IR Remote at the Challenger Front Panel.
- 2) Press the **2ND** key.
- 3) Press the **TOTAL** key.
- 4) Immediately press the **SCALE** key.
- 5) Immediately press the **TARE** key.

## CLEAR ALL TOTALS

### Function

The user may clear all totaled weights from the Total Register.

### Operation

If the USER key is programmed to “Total” then:

- 1) Aim the IR Remote at the Challenger Front Panel.
- 2) Press the **USER** key.
- 3) Press the **ZERO** key.

If the USER key is not programmed to “Total” then:

- 1) Aim the IR Remote at the Challenger Front Panel.
- 2) Press the **2ND** key.
- 3) Press the **TOTAL** key.
- 4) Immediately press the **SCALE** key.
- 5) Immediately press the **ZERO** key.

## KEYBOARD TARE

### Function

A tare value can be entered using the numeric keypad. Once the value is entered the scale will change into the NET mode.

### Operation

- 1) Aim the IR Remote at the Challenger Front Panel.
- 2) Press the numeric keys for the Tare value desired. Verify as you enter the number, that each number appears on the Challenger display.
- 3) Press the **TARE** key to input the number as a Tare value.

**Note:** If the value entered exceeds capacity the message “2 biG” appears on the display.

The TOTAL key functions as a decimal point, if needed.

To enter a Tare value less than 1, start with the **0** key followed by the Decimal Point. e.g. “0.5”. Use the **CLR** key to delete incorrect entries.

#### **Final**

- 1) The scale mode changes to NET.
- 2) The tare value is subtracted from all readings.

## DISP KEY

#### **Function**

The DISPLAY key gives control of the brightness of the LED digits and annunciators. In low ambient light, it is advantageous to dim the LEDs since dimmer digits require less energy and extend battery life. Use the DISP key to adjust the display for the minimum brightness that is easily legible at the distances and light conditions you use the most.

**Note:** The AUTO mode for the display brightness (see “SETUP – LEDS”) will automatically dim the display when no activity is detected. Push any key on the IR Remote to wake the Challenger up. This activity is independent of the display key.

#### **Operation**

- 1) Aim the IR Remote at the Challenger Front Panel.
- 2) The DISP key will cycle the display brightness from lowest to highest and then back to lowest.

## SETPOINTS

#### **Function**

Setpoint values are entered directly from the numeric keypad.

#### **Operation**

For a Setpoint that responds when the weight is greater than or equal to the Setpoint Value:

- 1) Aim the IR Remote at the Challenger Front Panel.
- 2) Press the numeric keys for the Setpoint value desired. Verify as you enter the number, that each number appears on the Challenger display.
- 3) Press the **SETPT1** or **SETPT2** key to input the number as

a Setpoint value. The message “StPt 1” or “StPt 2” appears for 2 seconds verifying the scale has stored the setpoint value in memory.

For a Setpoint that responds when the weight is less than or equal to the Setpoint Value:

- 1) Aim the Remote controller at the Challenger Front Panel.
- 2) Press the numeric keys for the Setpoint value desired. Verify as you enter the number, that each number appears on the display.
- 3) Press the **SETPT1** or **SETPT2** key to input the number as a Setpoint value.
- 4) While the message “StPt 1” or “StPt 2” appears, immediately push the **ID#** key. The display will change from “StPt 1” to “LESS” indicating that the setpoint is now set to respond when the weight is less than the value you put in.

**Note:** If the value entered exceeds capacity the message “2 biG” appears on the display.

The TOTAL key functions as a decimal point, if needed.

To enter a Setpoint value less than 1, start with the **0** key followed by the Decimal Point. e.g. “0.5”. Use the **CLR** key to delete incorrect entries.

## ID #

Not supported by the Challenger 2 at this time.

## PRINT

Not supported by the Challenger 2 at this time.

## SETUP

### Function

Setup functions are the same as when accessed by the Challenger Front panel. The keys used for entering and maneuvering through menus are simplified with the IR Remote. For a detailed description of the Setup functions, see Scale Setup, page 19 of this manual.

To Enable the Setup Menus

- 1) Aim the IR Remote at the Challenger Front Panel.

- 2) Press the **SETUP** key twice. The first menu “Func” (User Key function) will appear.

#### Key Functions While In Setup Menu

**USER**      Use these keys to scroll through the various menus, and to scroll  
or **UNITS:**    through the menu selections once in a menu.

**ENTER:**    The **ENTER** key is used to enter into menus, and to store the  
selection in memory once in a menu.

**CLR**            The **CLR** or **EXIT** keys are used to exit from menus  
or **EXIT:**      without changing the previously selected item. When in the top  
level of the Setup Menu, use the **CLR** key to return to normal  
scale operation.

**Note:** The Challenger 2 can also be controlled by the IR Remote during calibration. It is still necessary to enable calibration through the seal port, but from that point on, the Menu, Enter, Numeric, and Clr keys all simplify the calibration process.

## TROUBLESHOOTING GUIDE

Problem	Possible Cause	Solution
1. Display is blank when POWER button is depressed	A) Discharged battery B) Defective battery C) Corroded battery D) Defective button or electronic circuit board E) Power button not properly depressed	Recharge Replace Clean connections Requires authorized service  Press POWER firmly and hold until Power turns on.
2. Display does not function properly or front panel buttons do not function normally or scale will not turn off	A) Computer lock-up B) Faulty electronic circuit board C) Faulty front button assembly	Remove and re-insert battery. If problem persists, authorized service is required Requires authorized service  Requires authorized service
3. Display does not respond to weight changes	A) Same as 2A, B above B) Out of calibration C) Faulty load cell or electronic circuit board D) Load cell disconnected from printed circuit board	See 2A, B above Check calibration Requires authorized service  Plug in
4. Display over-ranges below 100% of capacity	A) Tared out weight is added to load when overload condition is determined B) Zero requires adjustment C) Out of Zero range	Normal (See Operation Guide)  Recalibrate  Remove dead load and re-zero
5. Display experiences excessive Zero drift between weighments	A) AZt turned off B) Scale electronics do not stabilize after turning on (probably due to rapid temperature change)	Go into Cal menu and turn AZt on Warm up scale for 5 minutes then re-Zero
6. Display shows large number after Power-up sequence with AZt feature Off, and no applied weight	A) ZERO requires adjustment B) Defective load cell or electronic circuit board	Follow Calibration Section Requires authorized service
7. Displayed weight shows large error	A) Scale not Zeroed before applying weight B) Requires recalibration C) lb/kg in wrong selection	Depress ZERO before applying weight  See Calibration Set to correct selection

Problem	Possible Cause	Solution
8. Display reading not stable	A) Filter set too low B) Faulty electronic circuit board	Change filter setting Requires authorized service
9. Battery charger indicator does not come on when discharged battery is inserted	A) Corroded battery connections B) Defective charger C) Defective battery	Clean connections Requires authorized service Replace
10. Display is "LCnt1" and/or "LCnt2" at Power on	A) Service Counter exceeded	Inspect load train; and contact factory
11. Display toggles between "Error" and "A2dLo" or "A2dHi"	A) Broken wire or improper connection B) Unit mis-calibrated C) Load cell damaged	Check load cell wiring for connectivity Re-calibrate with Initial Calibration Replace load cell
12. Display toggles between "Error" and "buttn"	A) A button is being depressed, or button is stuck	Release button, or contact qualified service technician
13. Display toggles between "Error" and "LOAd"	A) Current weight is greater than rated capacity B) Load cell damaged C) Defective electronics D) Broken wire or improper load cell wiring	Remove excess weight Replace load cell Contact qualified service technician Check Load Cell connection wiring
14. IR Remote does not work	A) The desired set of keys is not active B) The access codes are incorrect C) The Challenger 2 is not set up to receive infrared commands D) The batteries in the IR Remote controller are dead	Press 2ND or SCALE to activate the correct set of IR Remote keys. (See "THE SCALE AND 2ND KEYS") See "TO SET REMOTE CONTROLLER ACCESS CODES" See "TO ENABLE REMOTE CONTROLLER" Replace 2 'AAA' batteries with new.
15. Some IR Remote keys do not work	A) IR Remote is in wrong mode B) Remote not programmed	See "THE SCALE AND 2ND KEYS" Reset remote access codes. See "TO SET REMOTE CONTROLLER ACCESS CODES"

---

## SERVICE COUNTER WARNING

**Function**

A Warning is reported at Power On if:

Capacity of the scale has been exceeded more than 1,000 times or a weight in excess of 25% of capacity has been detected more than 100,000 times. This warning informs the operator that the load train should be inspected by a qualified technician.

**Action**

If a weight in excess of 25% of capacity has been detected more than 100,000 times, then "LCnt2" (Load Counter #2) is displayed, followed by the flashing numeric value. To continue with Power On, press any button.

**Final**

Power On sequence continues.

**Note:** If Service Counter Warning has not been reset, it will be displayed the next time POWER is turned on, with the updated numeric values.

---

## THE MSI LIMITED WARRANTY

MEASUREMENT SYSTEMS INTERNATIONAL, INC., WARRANTS load sensing elements and meters against defects in workmanship and materials for a period of one year from date of purchase and warrants electrical cables and batteries against the same defects for a period of ninety (90) days from date of purchase.

Any device which proves defective during the warranty period will be replaced or repaired at no charge; provided that the defective device is returned to the Company freight prepaid.

In no event shall the Company be liable for the cost of any repairs or alterations made by others except those repairs or alterations made with its specific written consent, nor shall the Company be liable for any damages or delays whether caused by defective workmanship, materials or otherwise.

The Company shall not be liable for any personal injury or property damage resulting from the handling, possession or use of the equipment by the customer.

The warranty set forth herein is exclusive and is expressly in lieu of all other warranties, express or implied, including without limitation any implied warranties of merchantability or fitness, or of any other obligations or liability on the part of the Company.

The liability of the Company under this warranty is limited solely to repairing or replacing its products during the warranty periods; and the final judgement and disposition of all claims will be made by MEASUREMENT SYSTEMS INTERNATIONAL, INC.

PROPER LOADING PROCEDURES

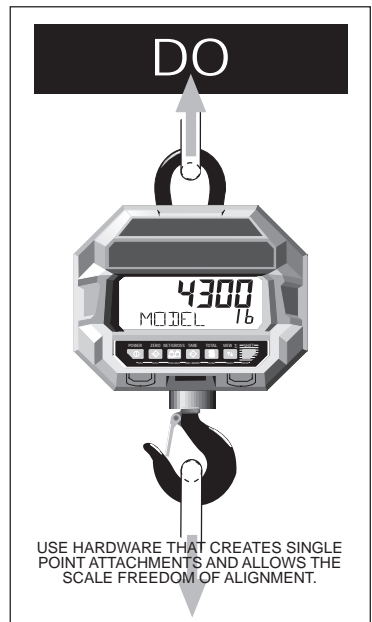
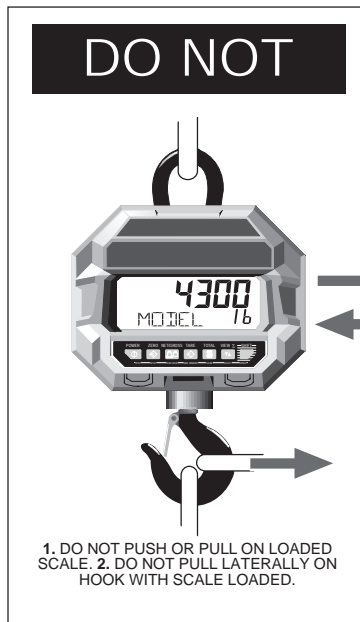
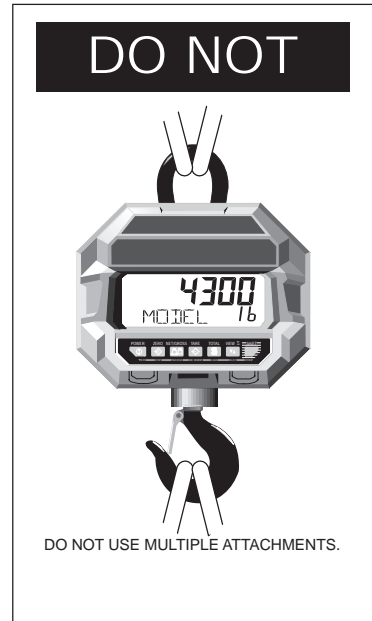
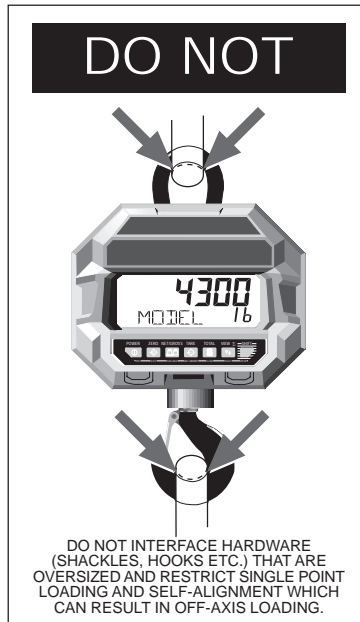

PUB.PLP-01-95

---

NOTES



©2009 by Measurement Systems International  
Printed in U.S.A.  
PUB.230-07-93E



14240 INTERURBAN AVENUE SOUTH STE. 200  
SEATTLE, WASHINGTON 98168-4661 U.S.A.  
PHONE: 206-433-0199 • FAX: 206-244-8470  
E-MAIL: [info@msiscales.com](mailto:info@msiscales.com) • WEB: [www.msiscales.com](http://www.msiscales.com)